

Item	Specification
Clear-span width	30m
Eave height	4m
Ridge height	8.9m
Roof pitch	18°
Bay distance	5m
Longest component	10.7m
Minimum tent length	25m
Roof fixing	Bar tensioning
Main profile	256x121x5mm(4-channel)
Wind loading	100km/hour 0.5kn/m ²
Eave connection	Hot-dip Galvanized twin steel plate
Framework material	Hard pressed extruded aluminium 6061/T6 (15HW)
Cover material	PVC-coated polyester textile, flame retardant to DIN 4102 B1,M2,CFM. 750g-900g/m ²

Optional accessories
PVC window sidewalls
Anchoring
Rain Gutter
Lining and curtain
Glass door units
Hard walling system
Glass walling system
Transparent PVC cover and sidewall
Flooring system
Weight plate

Framework main profile dimension and use		
 <p>upright support Roof Beam</p>	 <p>Gable pole</p>	
 <p>Ridge purlin Eave purlin Gable beam</p>	 <p>Intermediate purlin</p>	 <p>Eave tension rail</p>

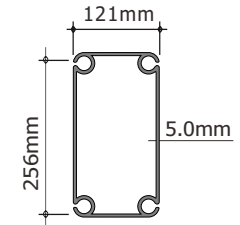
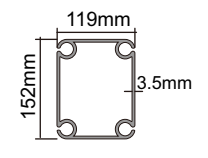
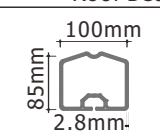
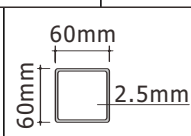
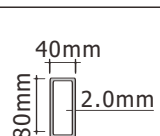