

1. Specification of A/C: (Model: BKF-29ZW)

Cooling Capacity: 26kW (8US. RT,100000BTU)	Wind Pressure: 150Pa
Cooling Air Flow : 5600M ³ /H	Input Power : 10kW
Host Dimension: 1700x1050x1100mm(LxWxH)	Running Current : 19A
Plenum Chamber Dimension: 1050x450x1100mm	Power Supply : 380V/50HZ
Applicable Area : 100-150m ²	Weight: 450kg

2. Outline Dimension Drawing

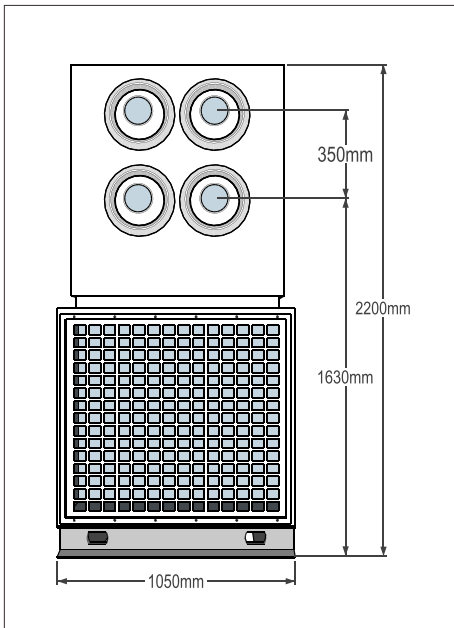

Front View

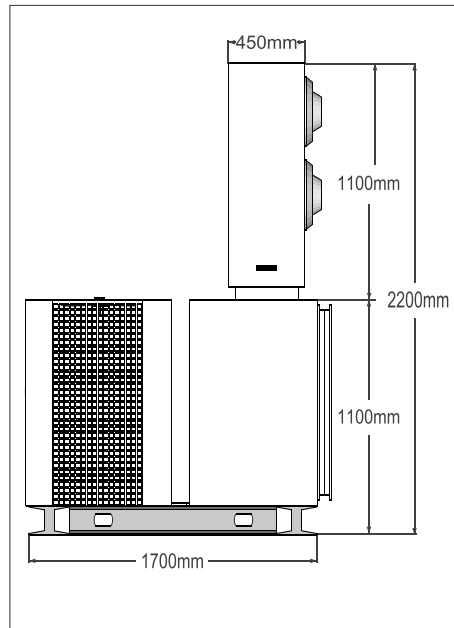

Side View

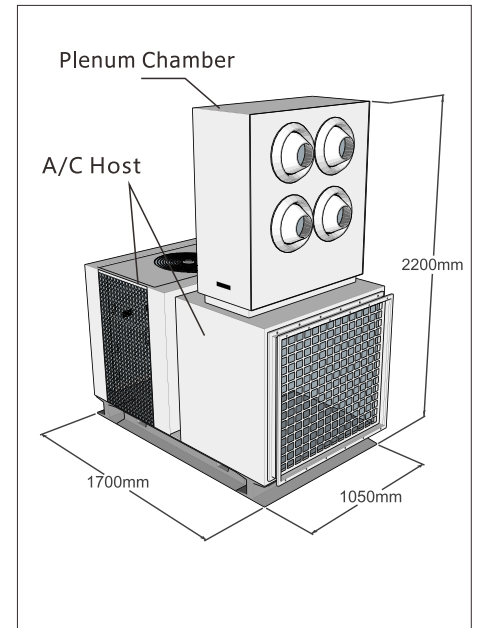

Perspective View

3. Installation & Operation Demonstration





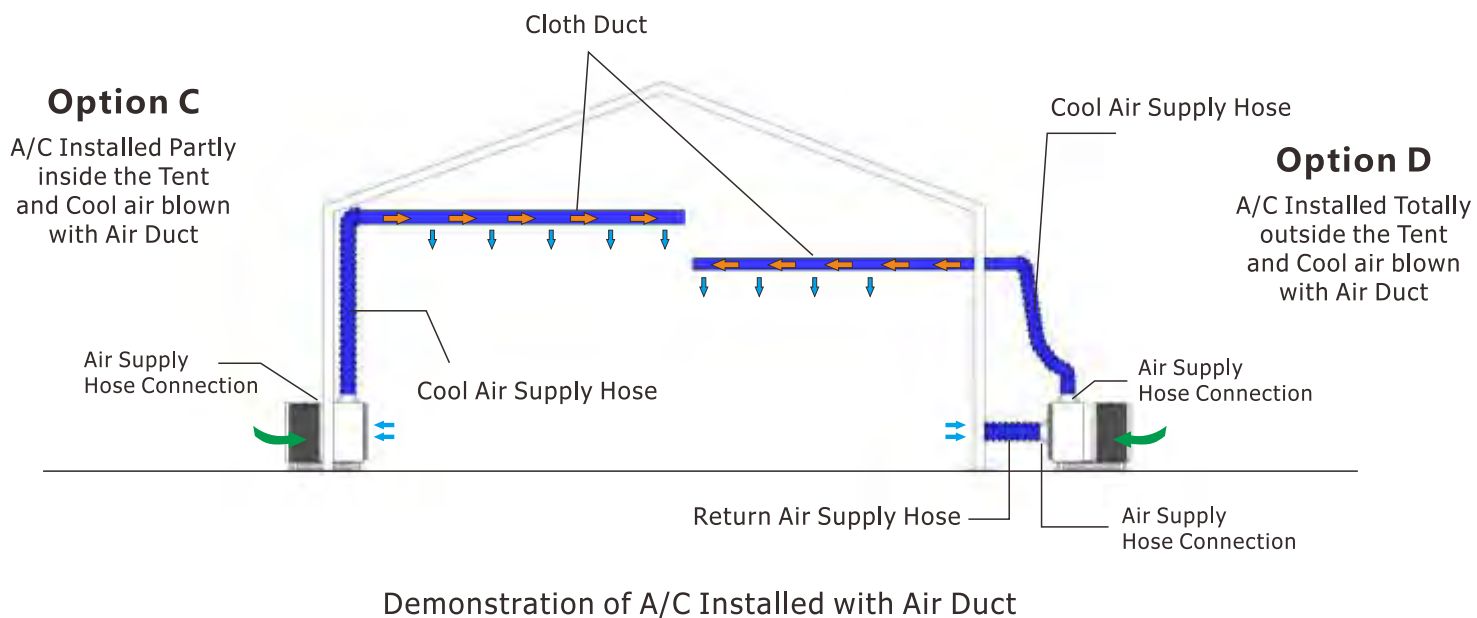

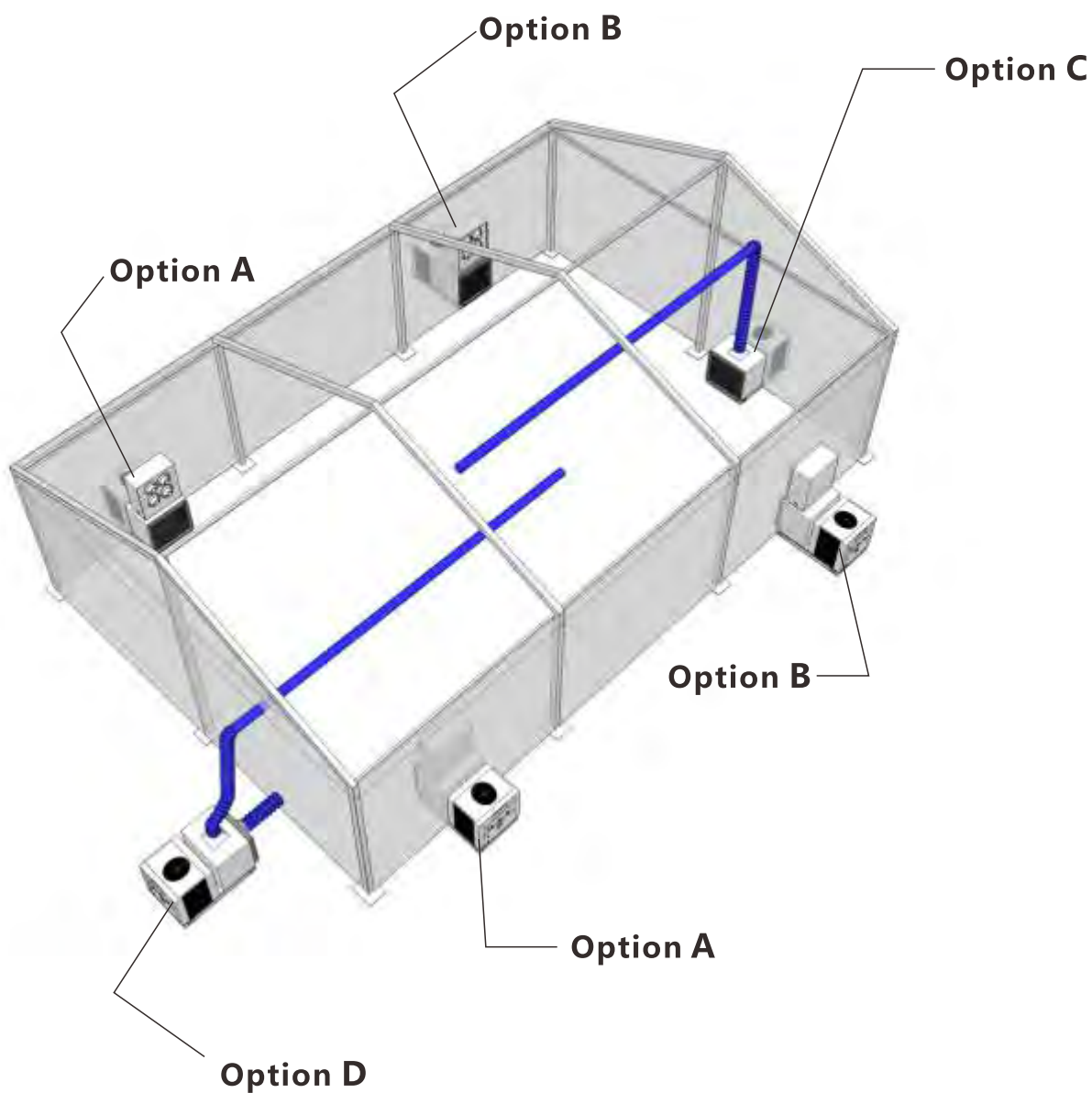

Demonstration of A/C Installed Inside and Outside the Tent



4. Living Examples of A/C Installation

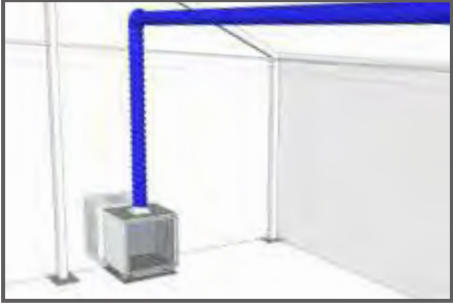
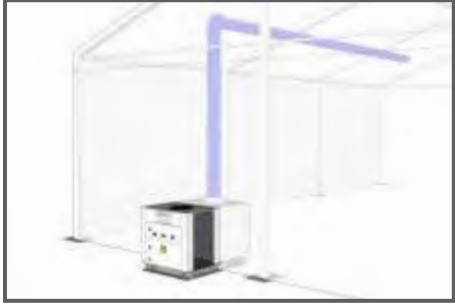
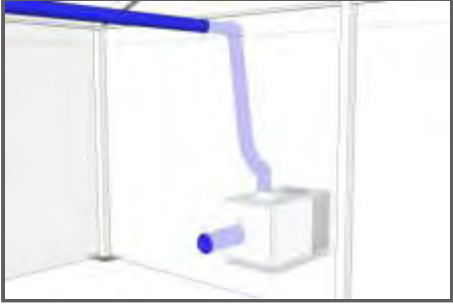

<p>Option A: A/C Installed Partly inside the Tent and Cool air blown with Plenum Chamber</p>		
<p>Option B: A/C Installed Totally outside the Tent and Cool air blown with Plenum Chamber</p>		
<p>Option C: A/C Installed Partly inside the Tent and Cool air blown with Air Duct</p>		
<p>Option D: A/C Installed Totally outside the Tent and Cool air blown with Air Duct</p>		

5. 10HP A/C Main Components :

